

CPCD 120-160 G系列12-16吨内燃平衡重式叉车
G series Balance Weight Type Forklift



HELI
中国合力 提升未来



CPCD 120-160
G系列12-16吨内燃平衡重式叉车
G series Balance Weight Type Forklift

设计印刷 合力印务 hell copyright 170414



安徽合力股份有限公司
ANHUI HELI CO., LTD.

地址: 合肥市经开区方兴大道668号
咨询电话: 0551-63689111
融资租赁: 0551-63689365
传真: 0551-63689365
网址: <http://www.helichina.com>
邮箱: sale@helichina.com

ADD:NO.668FangxingStreet,EconomicalDevelopmentZone,Hefei,P.R.China
TEL: (86 551)63639068(America)63639258(Europe) 63639358(Asia)
63662105(Africa&MiddleEast)63639530(Warehouse Equipment)
63639531(Wheel loader)
FAX:(86551)63639966
WEBSITE:<http://www.helichina.com>
Email:heli@helichina.net

我们的实力 Our Strength

安徽合力股份有限公司系安徽叉车集团有限责任公司核心控股子公司，1996年在上海证券交易所上市，注册资本6.168亿元，是我国目前规模大、产业链条完整、综合实力强的工业车辆研发、制造与出口基地。

Anhui Heli Co. Ltd., a core holding subsidiary of the forklift group, was listed in Shanghai Stock Exchange in 1996 and its registered capital is 616.8 million. It is presently an industrial vehicle research and development, manufacturing and export base in China with large scale, complete product line and industrial chain and strong overall strength.



行业地位 Position in industry

公司的叉车和零部件产品在国内同行业中规格最全、规模最大，叉车的综合性能处于国内同行业龙头地位，部分产品达到国际先进水平。各项主要经济指标已连续多年高层全国同行业之首。

We have the most completed forklift and parts among the same industry in China; The performance of the truck stays at the leading position among the same industry in China and some products reach to international advanced level. Major economic indicators rank top 1 for consecutive many years among the same industry in China.



科研实力 Scientific research ability

公司技术中心是1995年由国家发改委等四部委首批认定的100家国家级“企业技术中心”之一。学科齐全，基础设施雄厚。

The technical center of the company was honored as one of the first batch of "enterprise technical center at national level" in 1995 by National Development and Reform Commission together with other three ministers and commissions. We have complete research sectors and rich infrastructure.

我们的实力 Our strength



重要奖项 Key awards

近5年，公司自主研发的新产品获得6项科技进步奖，安徽省科技进步一等奖2项，机械工业科技进步二等奖一项。

In recent 5 years, New products with our independent research and development win 6 awards for scientific and technological advancement, 2 first prize wards for scientific and technological advancement in Anhui Province and 1 second prize award for scientific and technological advancement in mechanical industry.

HELI

全球合力 HELI around the world

2006年，叉车集团进入世界工业车辆行业10强，2011年位居国际第8位。公司在国内拥有自主营销网络，建立了24个省级营销网络和400多家二级代理销售服务网点，拥有完善、健全的服务体系。在海外80个国家和地区建立了海外代理网络，产品销往世界140个国家和地区，其中欧美地区占公司出口量的60%

HELI ranked top 10 among the world industrial truck sector in 2006 and top 8 from 2011. HELI has autonomous sales network and sound service system with 24 provincial sales network and more than 400 second level dealers in domestic and in overseas, HELI sets up sales network in more than 80 countries and regions and out products sell to 140 countries and regions over the world among which 60% of our products are sold to Europe and America.

品牌理念 Brand concept

合力以进入世界工业车辆五强为近期目标，立志成为国际一流、基业长青的企业。

百年合力是我们的理念定义，世界五强是我们量化的目标。合力人一步一个脚印，不断拼搏进取，逐渐把企业做大做强。进入新世纪以来，合力进入了一个飞速发展的时期，在2006年成功跻身世界叉车行业十强。今天我们提出跻身世界叉车行业第一集团，进入世界五强的目标，是对我们辉煌的历史的传承，更是合力人永不停息的脚步！

With being world top 5 as the short-term goal, HELI is committed to be a world first-class and over-lasting enterprise.

Centennial HELI is our definition in thought and world top 5 is our quantized goal. HELI people work steadily and keep forging ahead to make our enterprise bigger and stronger. HELI has gone to a fast developing time since the new century. In 2006, HELI ranked world top 10. Now, we make our decision to be world top 5 which is not only a heritage of our glorious history but also our never-ending hard effort.

重型(港口)机械制造基地 heavy machine manufacturing base

依托公司强大的科研平台及制造能力，合力公司研发、生产、销售系列齐全，品种多样的重型叉车、正面吊、集装箱空箱堆高机，为客户提供专业的物流搬运解决方案。

重型叉车：12t-18t、20-25t、28-32t、35t、38-40t、42-46t

正面吊：标准型正面吊、重载型正面吊

堆高机：2-3层、5-6层、7-8层

Based on HELI strong scientific research platform and manufacturing ability, HELI research and develop, produce and sale heavy trucks, reach stacker and empty container handler with completed series and various types to provide customers with special material handling solutions.

Heavy truck: 12t-18t、20-25t、28-32t、35t、38-40t、42-46t

Reach stacker: standard type reach stacker, heavy type reach stacker

Container handler: 2-3 layer, 5-6 layer, 7-8 layer

A. 持久耐用 Enduring and durable

A.1 牢固耐用的结构设计 Durable structure design

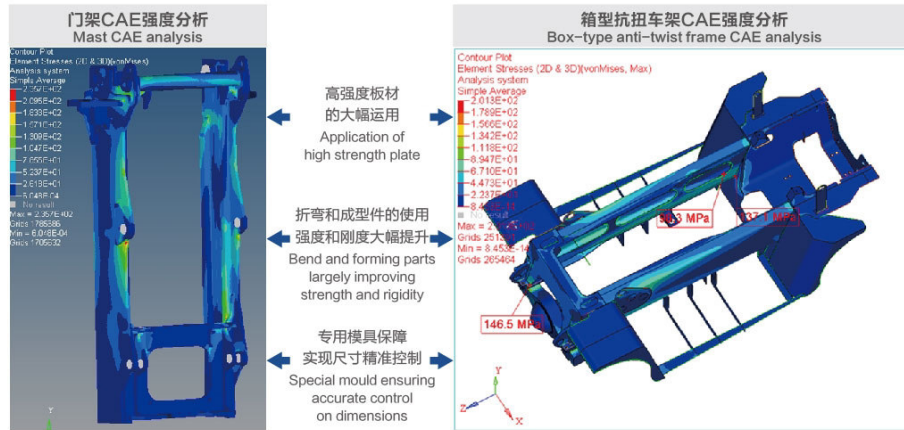

A.2 便捷高效的点检维护 Easy and high efficient daily inspection

▶ 驾驶室电动倾翻系统 Cab electric tilting system

自动倾翻系统使得内部维护方便快捷，电动辅助液压驱动倾翻油缸使驾驶室向右侧倾翻60°，易于维修保养。

Automatic tilting system facilitates interior maintenance; Hydraulic drives tilting cylinder with electric assistance making cab tilt 60° right ward which makes maintenance easy.

▶ 大角度掀翻机罩 Engine hood with large opening angle

敞开式发动机机罩，保证快速高效的维护，通过两个自锁式气弹簧安全便捷打开机罩。

Open type engine hood which can be open through two self-lock spring ensures easy and high efficient maintenance.



▶ 油水加注检查便捷 Easy liquid adding and check

冷却液加注检查、燃油加注，液位检查、油水分离器更换、机油加注检查、液压油油位检查等更加便捷。

Cooling liquid adding and check, fuel adding, level check, oil-water separator replacement, engine oil adding and check and hydraulic oil level check become easier.



- 冷却液加注检查便捷
Easy cooling liquid adding and check
- 燃油加注，液位检查便捷
Easy fuel adding and check
- 液压油油位、油质检查便捷（液位计）
Easy hydraulic oil level and quality (hydraulic oil level gauge)
- 油水分离器更换维护便捷
机油加注检查便捷
Easy oil-water separator replacement and maintenance
Easy engine oil adding and check

A.3 防护性能提升 Improved protection performance

- 油缸保护套
- 高防尘防水等级电动倾翻按钮
- 线束防护等级提升
- 插件防尘防水
- 防尘透气帽
- 高强度铝板翅散热器
- 燃油管安全等级提升
- Oil cylinder protection sleeve
- Electric tilting button with high dust-proof and water-proof degree
- Improved harness protection degree
- Dust-proof and water-proof plus and sockets
- Dust-proof vent
- High strength aluminum plate fin type radiator
- Improved fuel pipe safety degree



- 高强度板翅结构—翅片不易变形开裂：
外表面注塑处理—耐腐蚀耐氧化
high strength fin type structure will not deform or crack easily.
Exterior injection molding treatment---anti-corrosion and oxidation resistance.



- 油缸防护套（选配）：此护罩有助于防止外物造成的油缸损伤
Oil cylinder protection sleeve(optional): it is used to protect cylinder damaged from foreign matters



- 高防尘防水等级电动倾翻按钮：防护等级IP67
Electric tilting button with high dust-proof and water-proof degree: protecting degree:IP67

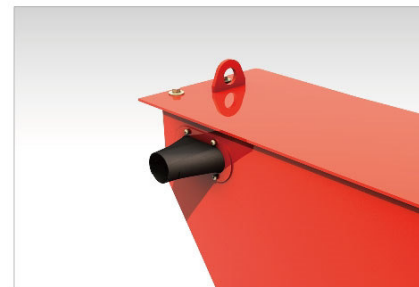

- 电气柜防尘套
Dust-proof sleeve for electric cabinet

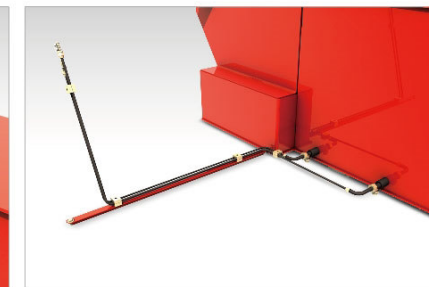

- 进回油管用成型钢管替代胶管：安全等级大幅提升
Molding steel pipe is used for oil suction pipe improving safety degree largely.



- 前桥防尘透气帽
Front axle dust proof vent



- 变速箱防尘透气帽
Transmission box dust proof vent

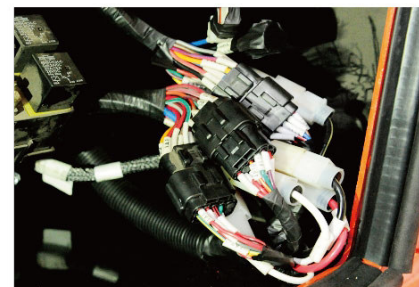

- 防尘防水接插件：防护等级IP65
Dust proof and water proof sockets and plugs: protection degree IP65



- 线束采用全新德标，耐温极限大幅提升（-40℃-105℃）
Harness meets German standard and its temperature resistance ability is largely improved（-40℃-105℃）.

A.4 冷却效率提升 Improved cooling efficiency

- 风道优化设计
- 散热器翅片尺寸合理分布
- 风扇的优化设计
- Optimal designed channel
- Reasonable layout of radiator's fins
- Optimal designed fan



- **风道优化设计**
散热器的优化布置及风道的特别设计，使冷却系统进风出风阻力很小，有效防止空气涡流回流，大幅提升散热效率。
- **Optimal designed channel**
Optimal designed radiator and channel makes cooling system has small resistance, avoid air flowing back effectively and improves cooling efficiency.
- **风扇的优化设计**
经过大量对比试验，选用多叶片，风量风压足，消耗功率合适的轴流风扇，专为G系列车型定制。
- **Optimal designed fan**
Axial fan with multiple blade, enough blast capacity and pressure and consume power is special for G series based on a large number of comparative tests.



B. 节能环保 Energy saving and environment friendly

B.1 高效匹配,动力强劲 high efficient matching, forceful power

- ▶ **Cummins QSB6.7 发动机 Cummins QSB6.7 engine**
强劲、可靠、经济，是这款六缸四冲程涡轮增压发动机所具备的特性，它满足国III排放标准，环保节能。
Six cylinder four stroke turbocharged engine which is powerful, reliable, and economic and meets China III is assembled on the truck.
- ▶ **ZF 变速箱 ZF transmission box**
平顺的换挡节奏，无冲击；
智能的换挡模式，更便捷；
高效的动力匹配，更节能。
Smooth gear shifting without shock.
Intelligent gear shifting mode is easier.
High efficient power match is more energy saving.



B.2 液压动态负载变量控制系统 Hydraulic dynamic load variable control system

- ▶ 根据驾驶员工作习惯及负载情况自动调节油泵排量，实现高精度流量控制，节能降耗效果显著。
It can adjust oil pump displacement automatically according to operator habit and load condition to achieve high precision flow control and energy saving.

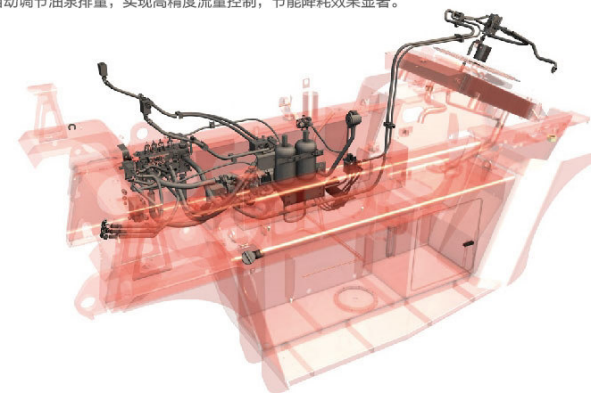

B.3 智能敏感热管理系统 Intelligent sensitive thermal management system

- 4合一的复合散热器，有效整合资源，节省空间。
- 即时热管理系统实时监控整机各散热介质温度曲线，实现风扇多级变速。
- 具有冬天气机快，夏天系统功率损耗更合理的特点，只吹该吹的风。
- 该系统节能10%，温度较低区域降耗15%，释放“心”动力，助你更快提升，拥有更优加速性能。
- 更优的匹配设计，风扇多级调速，降噪效果十分显著。
- Four in one compound radiator effectively integrates resource and saves space.
- Real time thermal managing system monitors cooling medium temperature curve of the completed truck and fan multilevel speed changing is achieved.
- The truck is heated quickly in winter and in summer, the system power consumption is more reasonable.
- The system saves 10% of the energy and consumption in low temperature area is 15% reduced.
- Better matching design; multilevel fan speed; outstanding noise reducing effect.



智能敏感热管理系统

- 电控系统
实时监控各介质温度，控制风扇转速
- 液压系统
为风扇旋转提供独立的动力源，区别于传统发动机直连风扇，可实现风扇多级调速
- 冷却系统
特别设计的4合一复合散热器、优化设计的风道以及风扇。

Intelligent sensitive thermal management system

- Electric control system
Real time thermal managing system monitors cooling medium temperature curve of the completed truck to control fan speed.
- Hydraulic system
Fan is powered by separated power which is different from traditional direct connection fan to achieve fan multilevel speed changing.
- Cooling system
Four in one compound radiator, optimized air channel and fan the air duct and the fan.

B.4 轻量化设计 Light type design

- ▶ 后配重不开风道，配重利用率提升约5%，整车自重降低
- ▶ 轻量化设计，优化结构，更轻更强
- ▶ Rear counter weight has no air channel and counter weight use ratio is 5% increased and thus truck service weight is reduced.
- ▶ Light type design optimizes structure and the truck is lighter and more stable.



▪ 后配重无风道设计

G系列车型独特的冷却系统布置形式及温控系统，后配重无须开风道孔，提高了配重利用率，降低整车自重，更加节能。

- Counter weight no air channel design
Special cooling system layout and temperature control system are adopted on G series truck. rear counter weight has no air channel and counter weight use ratio is increased and thus truck service weight is reduced.



▪ 轻量化设计

- 高强度板材运用；
- 多年的数据积累及精细的CAE分析；
- 不断优化的结构设计；
- Light type design
• Application of high strength material.
• Years of data accumulation and accurate CAE analysis.
• Constant structure optimization.

C. 舒适便捷 Comfort and convenient

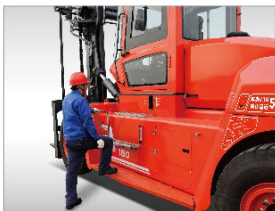

C.1 上下车便捷 Easy get on-off

- 大尺寸上车踏板和扶手
敞开式台阶为进出车辆提供便捷和安全
- 防滑踏板设计
防滑式铝质踏板为进出驾驶室提供优异的防滑性能
- 辅助扶手
坚固耐用
- Large getting on off pedal and handrail
Open type steps make easy and safe get on-off.
- Anti-skid pedal
Anti-skid aluminous pedal has good anti-skid performance.
- Auxiliary handrail
Solid and durable

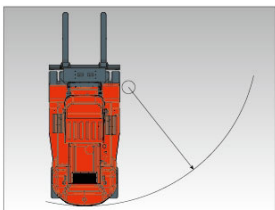

C.2 更小的转弯半径 Smaller turning radius

- 更小的转弯半径
紧凑的车身设计
优化的转向角度
- Smaller turning radius
Compact frame design
Optimized steering angle



C.3 门架下缓冲 Mast lower buffering

- 门架下缓冲
减少门架下降时的冲击振动
- Mast lower buffering
Reduce the shock when lowering



C.4 极佳的视野 Superior view

- 卓越的前方视野
前玻璃采用大圆弧多曲率造型，提升前方视野张角10°
- 卓越的上方视野
驾驶室顶置大面积玻璃，抬头即可见
- 卓越的后方视野
驾驶室后方设置1200mmx900mm大面积玻璃，视野极佳
- 左右侧窗玻璃
左右侧门设置4块窗口玻璃，360°全方位照顾您的眼界
- 专业的人机视野分析
- Superior front view
Front glass with large arc is used and front view field angle is 10° increased.
- Superior top view
Large glass is used on the top of cab.
- Superior rear view
1200mmx900mm glass is used at the rear end of cab.
- Glass for left and right side window
4 pieces of glass is used on left and right door to ensure 360° view.
- Professional ergonomics view analysis



- 后视系统（选配）
后方倒车视野可实时显示
Rear vision system (optional)
truck real time rear view can be displayed when backward.

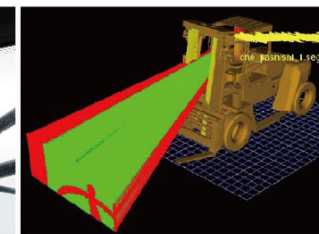

- 前方视野校核
Front view check

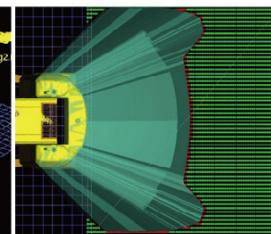

- 后方视野校核
Rear view check



- 随动操纵台**
 人机工程优化，多次试验验证，完成操纵台与座椅SIP点最合理的相对位置设置，操纵台与座椅整体随动，适应不同人群随心所欲的驾乘设置。
Moveable dashboard
 Most reasonable relative position is set between dashboard and seat SIP point through optimized ergonomic and multiple test. Dashboard and seat can be moved together to meet different driving needs.
- 称重系统（选配）**
 通过检测液压压力来准确测量载荷。
Weighting system(optional)
 Weight can be measured accurately through checking hydraulic pressure.
- 倒车雷达（选配）**
 六点监控，分布合理
 监控范围更广
Backward radar(optional)
 Monitor is achieved through reasonable distributed 6 points.
 Larger monitoring range



- 全悬浮座椅**
 可调节阻尼减震设计，托起你应有的重量，享你应有的平稳。
Fully suspension seat
 Adjustable damping shock reducing design not only bears your weight but also provides steady driving experience.
- 可调节方向盘**
 根据操作者的习惯来调节方向盘，轻便灵活的转向大大减少工作强度。
Adjustable steering wheel
 Steering wheel can be adjusted according to operator habit and easy and flexible steering largely reduces your work.
- 踏板优化布置**
 人机工程优化布置踏板位置，减少长时间工作疲劳，轻松驾驭工作。
Pedal optimized layout
 Optimized pedal reduces fatigue during long time working.

G.5 更舒适的驾驶体验 More comfort driving experience

全新360° 视野专属驾驶室
special cab with 360° view

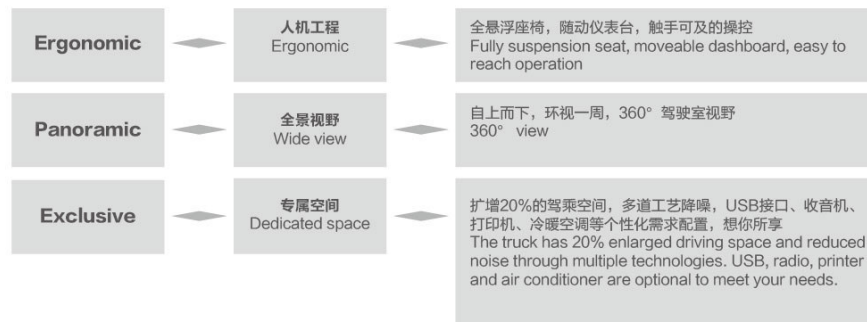

- 多风道温度控制系统**
 严格密封的驾驶室带来高效的温度控制，多风道无死角空气对流维持驾驶室温度均衡持久，给夏日送去清凉，给冬日带来温暖。
Temperature control system through multiple channel
 Fully sealed cab controls temperature in the cab high efficiently and multiple channels cross ventilation keep the temperature in the cab stable. winter.
- 灵活的操控手柄**
 使用最小的操控力就能达到精确的、安全的和富有成效的控制。
Flexible control knob
 Accurate, safe and effective control can be achieved through small operation force.

D. 安全高效 Safe and high efficient



D.1 稳定性更好 Better stability

- 更小前悬
门架结构设计更加紧凑
- 重心后移
 - 动力总成后置
 - 冷却系统后置
 - 配重不开风道孔
- Smaller front overhang
More compact mast structure
- Retroposition of center of gravity
 - Retroposition of power system
 - Retroposition of cooling sytem
 - No air channel on the balance weight

D.2 OPS(操作者存在感应系统) (选配) OPS (optional)

- 整车OPS系统 (可选)
操作人员离开座位时, 整车自动断开动力, 无行走
- OPS for the whole truck (optional)
Truck power will be cut automatically and the truck can not be operated when operator is away from seat.
- 门架OPS系统 (可选)
操作人员离开座位时, 门架锁死, 无动作
- OPS system for mast (optional)
The mast is locked and can not be operated when operator is away from seat.



D.3 湿式驱动桥 Wet type drive axle



- 免维护
特殊的结构设计和制动原理，防尘防水，为您节约维护成本
- 制动安全可靠
满足长时间高强度短距离频繁制动作业需求。
- Maintenance free
Specially designed structure and brake principle provides anti-dust and anti-water function and saves your maintenance cost.
- Safe and reliable brake
Working requirements such as Long time, high duty, short distance or frequent brake can be satisfied.

D.4 高效作业 high efficient working



- 操作高效 High efficient operation
 - 整机动作液压先导远程控制，操作精度高，响应速度快
 - 集成式的操纵台，操控更便捷
 - 合理的人机工程布局，给您人机合一的操控体验
- Hydraulic pilot long distance control provide high operation accuracy and quick response.
- Integrated dashboard makes operation easy.
- Reasonable ergonomics layout provides you human-machine friendly operating experience.

▪ 性能高效 High efficient performance

- 更快的运转速度
更陡的爬坡度
强劲的动力输出使整车有更好的加速性能和爬坡度
Faster working speed
Better gradeability
Forceful power output provides truck better acceleration performance and gradeability.



E. 技术参数 Technical parameters

性能参数 Technical parameters

01	型号 Model	单位Unit	CPCD120-CZ-09IIIIG	CPCD135-CZ-06IIIIG	CPCD150-CZ-06IIIIG
02	额定载荷 Rated load	t	12	13.5	15
03	整车质量 The mass	kg	17385	17385	17800
04	最大起升速度 (满载/空载) Maximum lifting speed (loaded/unloaded)	mm/s	360/400	360/400	350/400
05	最大行驶速度 (满载/空载) Maximum speed (loaded/unloaded)	km/h	25/27	25/27	27/28
06	爬坡能力 (满载/空载) Climbing ability (loaded/unloaded)	%	36.4%/40%	36.4%/40%	36.4%/40%
07	驾驶室噪音 The cab noise	dB(A)	≤73.8	≤73.8	≤73.8

尺寸参数 Size parameters

01	型号 Model	单位 Unit	CPCD120-CZ-09IIIIG	CPCD135-CZ-06IIIIG	CPCD150-CZ-06IIIIG
02	总长L The total length		6705	6255	6255
03	总宽W The total width	mm	2560	2560	2560
04	总高H Total height	mm	3380	3380	3380
05	载荷中心距L1 Load center distance	mm	900	600	600
06	轴距L2 The wheelbase	mm	3250	3250	3250
07	前悬距L3 Before hanging from	mm	785	785	795
08	后悬距L4 Suspension from	mm	850	850	850
09	最小离地间隙H2 The minimum clearance from the ground	mm	260	260	250
10	座椅高度H4 Seat height	mm	2615	2615	2630
11	内转弯半径R1 The turning radius	mm	220	220	220
12	外转弯半径R2 The turning radius	mm	4450	4450	4500
13	前轮距W1 Before the wheel track	mm	1892	1892	1888
14	后轮距W2 After the wheel track	mm	2120	2120	2120
15	门架高度 (收缩H/伸出H1) The door frame height (contraction/out)	mm	3380/4880	3380/4880	3380/4880
16	门架起升距离H3 Door set up distance	mm	3000	3000	3000
17	门架倾角 (前倾α/后倾β) Door frame Angle (forward/backward)	deg	6/12	6/12	6/12
18	货叉尺寸 (长×宽×厚) Pallet fork size (length * width * thickness)	mm	1820×200×85	1370×200×85	1370×200×85
19	货叉调节范围 Goods fork adjusting range	mm	500-2370	500-2370	500-2370

01	CPCD160-CZ-06IIIIG	CPCD140-CZ-09IIIIG	CPCD150-CZ-09IIIIG	CPCD160-CZ-09IIIIG
02	16	14	15	16
03	18500	20500	21000	21500
04	350/400	370/415	370/415	370/415
05	27/28	26.2/27.3	26.2/27.3	26.2/27.3
06	36.4%/40%	36.4%/40%	36.4%/40%	36.4%/40%
07	≤73.8	≤73.8	≤73.8	≤73.8

01	CPCD160-CZ-06IIIIG	CPCD140-CZ-09IIIIG	CPCD150-CZ-09IIIIG	CPCD160-CZ-09IIIIG
02	6255	7105	7105	7105
03	2560	2560	2560	2560
04	3380	3340	3340	3340
05	600	900	900	900
06	3250	3500	3500	3500
07	795	935	935	935
08	850	850	850	850
09	250	275	275	275
10	2630	2630	2630	2630
11	220	220	220	220
12	4500	4750	4750	4750
13	1888	1895	1895	1895
14	2120	2120	2120	2120
15	3380/4880	3340/4840	3340/4840	3340/4840
16	3000	3000	3000	3000
17	6/12	6/12	6/12	6/12
18	1370×200×85	1820×200×90	1820×200×90	1820×200×90
19	500-2370	610-2390	610-2390	610-2390

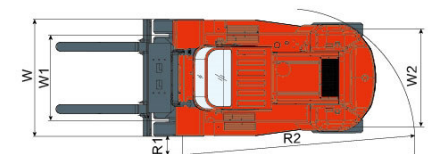
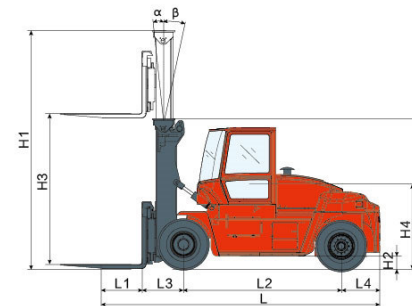
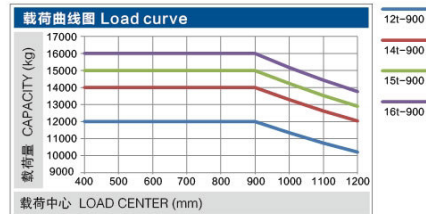
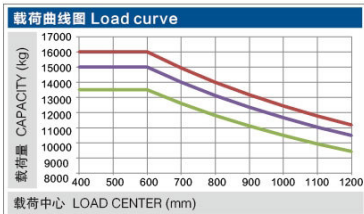

F. 配置表 Configurations

整车配置 The vehicle configuration					
01	叉车型号 Truck model		CPCD120-CZ-09IIIIG	CPCD135-CZ-06IIIIG	CPCD150-CZ-06IIIIG
02	发动机 The Engine	品牌 Brand	CUMMINS	CUMMINS	CUMMINS
		型号 Model	QSB6.7	QSB6.7	QSB6.7
		额定功率 (kW/rpm) Rated power (kw/rpm)	119/2300	119/2300	119/2300
		最大扭矩 (Nm/rpm) Rated torque (nm/rpm)	731/1500	731/1500	731/1500
		排放标准 Emission standard	EU Stage III	EU Stage III	EU Stage III
03	变速箱 Transmission	型号 Model	ZF131	ZF131	ZF131
04	驱动桥 Drive axle	型号 Model	美驰驱动桥 Meritor drive axle	美驰驱动桥 Meritor drive axle	美驰驱动桥 Meritor drive axle
05	轮胎 Tire	尺寸 Size	11.00-20	11.00-20	12.00-20
06	辅助性配置 Auxiliary configuration	倒车雷达 Backward radar	○	○	○
		倒车影像 Backward image	○	○	○
		称重系统 Weighting system	○	○	○
		整车ops Ops for the whole truck	○	○	○
		门架ops Ops for mast	○	○	○
		定量系统 Consistent rate system	●	●	●
07	液压系统 Hydraulic system	变量系统 Variable system	/	/	/
		冷暖空调 Air conditioner	○	○	○
08	空调选项 Air conditioner	单冷空调 Cooler	○	○	○
		全充气胎 Pneumatic tyre	●	●	●
09	轮胎选项 Tyre	全实心胎 Solid tyre	○	○	○
		前实心后充气 Solid tyre for front one and pneumatic tyre for rear one	○	○	○
		前充气后实心 Pneumatic tyre for front one and solid tyre for rear one	○	○	○
		驾驶室 Cab	倾斜驾驶室 Tilting cab	●	●

●-标配项 ○-选配项 /-非配项
●-Standard ○-Optional /-/

01	CPCD160-CZ-06IIIIG	CPCD140-CZ-09IIIIG	CPCD150-CZ-09IIIIG	CPCD160-CZ-09IIIIG
02	CUMMINS	CUMMINS	CUMMINS	CUMMINS
	QSB6.7	QSB6.7	QSB6.7	QSB6.7
	119/2300	142/2300	142/2300	142/2300
	731/1500	930/1500	930/1500	930/1500
	EU Stage III	EU Stage III	EU Stage III	EU Stage III
03	ZF131	ZF171	ZF171	ZF171
04	美驰驱动桥 Meritor drive axle	Kessler	Kessler	Kessler
05	12.00-20	12.00-20	12.00-20	12.00-20
06	○	●	●	●
	○	●	●	●
	○	○	○	○
	○	○	○	○
	○	○	○	○
	○	○	○	○
07	●	/	/	/
	/	●	●	●
08	○	●	●	●
	○	/	/	/
09	●	●	●	●
	○	○	○	○
	○	○	○	○
	○	○	○	○
10	●	●	●	●

● 合力产品不断更新和改进中，合力保留在没有事先告知用户的情况下，更改整体参数及设计的权利。
Our products are subject to the improvements and changes without notice.

● 文中插图不一定是该机型的标准款，插图中产品配置和外观颜色与实际机型存在差异，以实物为准。
The picture in the brochure may not be the standard model of this type. The configuration and color of the product in the picture may be different from the actual machine. Please adhere to the actual machine.

G. 选配表 Configuration

门架选配 Mast



- 标准型门架
适用于普通工况具有可变滚轮距，抗疲劳性更高
- Standard type mast
It is suitable for normal working condition. It has changeable tread and high fatigue resistance ability.



- 二级全自由门架
适用于室内、船舱或矮门等狭窄作业工况
起升缸外置，视野更佳
- Two-stage full free mast
It is suitable for narrow working conditions in doors, cabin and dwarf door. Extraposition lifting cylinder provides better view.



- 三级全自由门架
起升高度更大，整车高度更低，作业安全
- Three-stage full free mast
The truck has larger lifting height and lower truck height and thus it is safer.

属具选配 Attachments



- 调距叉
双叉调距，液压调节，快捷方便
- Fork positioner
It is easy and quick with two forks adjusting powered by hydraulic.



- 侧移调距叉
同时具备货叉调距与侧移功能，提高作业效率
- Side shifting fork positioner
It has both space adjusting and side shifting functions to improving working efficiency.



- 侧移器
侧移功能与调距功能独立，操作快捷
- Side shifter
Side shifting and space adjusting function are separated from each other to achieve quick respond.



- 货叉套
有效延长货叉，适用于较大外形货物的搬运
- Fork extension
It effectively extends fork and it is suitable for large size handling.



- 串杆
适用于钢卷、线材等成卷的货物
- Carpet boom
It is suitable for roll type goods such as steel roll, wire roll and so on.



- 吊臂
起吊货物安全高效
- Crane jib
It is safe and high efficient to lift goods.



- 管线材吊具
适用于成捆的钢筋、钢管等货物的吊运
- Slings
It is suitable for goods in bundle such as rebar, steel tube and so on.